



LEADING

THE

INNOVATION



ABOUT US

K2 CAD-E-M Technologies Pvt Ltd. is the Engineering & Design Solutions unit of **Polyplastics Group**. Since Year 2000 K2 CADEM has provided complete Product Design services to the entire Group and its Customers.

We are focused on Engineering & Design (E&D) and product-centric services and solutions, creating value for our clients through our best-in-the-industry innovative & consistently dependable services. Our state-of-the-art technology and a pragmatic approach to engineering and manufacturing processes that reduces costs and time to market; and helps clients realize superior products.

OUR MISSION

To provide total customer satisfaction and achieve leadership in the chosen markets, products and services across the globe through excellence in technology and innovation.

OUR VALUES

- INNOVATION
- CUSTOMER DELIGHT
- DEDICATION
- TEAMWORK
- TIMELINESS
- TRANSPARENCY



POLYPLASTICS GROUP HISTORY & MILESTONES

- **1967** Founded by Mr. B. R. Gupta with a small tool room.
- **1982:** Diversified into manufacturing of Automotive plastics parts.
- **1988:** Installed in-house manual Electroplating facility on ABS.
- **1996:** Started production of full Wheel Rim Covers.
- **2009:** Pune Plant established with Molding & Painting facility.
- **2010:** Second state of the art Plating facility made operational in Pune.
- **2010:** A subsidiary unit established for Wheel Rim Cover and Chevy Bowties in Yamuna Nagar.
- **2011:** Established Vacuum metalizing plant at Yamuna Nagar.
- **2013:** Take over of new plant “Euro American Plastics Products Pvt. Ltd”. in Bhiwadi.
 - : IMD (In Mold Decoration) installation in Yamuna Nagar.
- **2014:** Chennai Plant inaugurated to cater the South based customers.
- **2015:** Bawal Plant operationalized with injection molding and painting facility.
- **2016 :** Bhiwadi Plant operationalized with injection molding and body color painting for door handles
- **2017:** Sanand plant operationalized with wheel cover and injection moulding facility.
- **2018:** 3rd Plating Line operationalized at Bhiwadi Plant.
- **2019:** New Rotary Robotic Paint Line operationalized at Bhiwadi Plant.
 - New Technology “Kromex” Machinery installed at Bawal Plant.

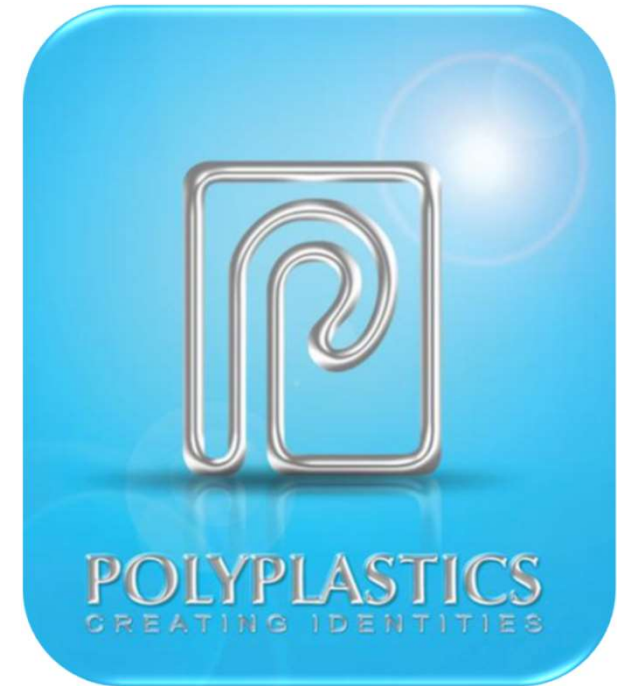

POLYPLASTICS GROUP PRESENCE



OUR CORE COMPETENCE

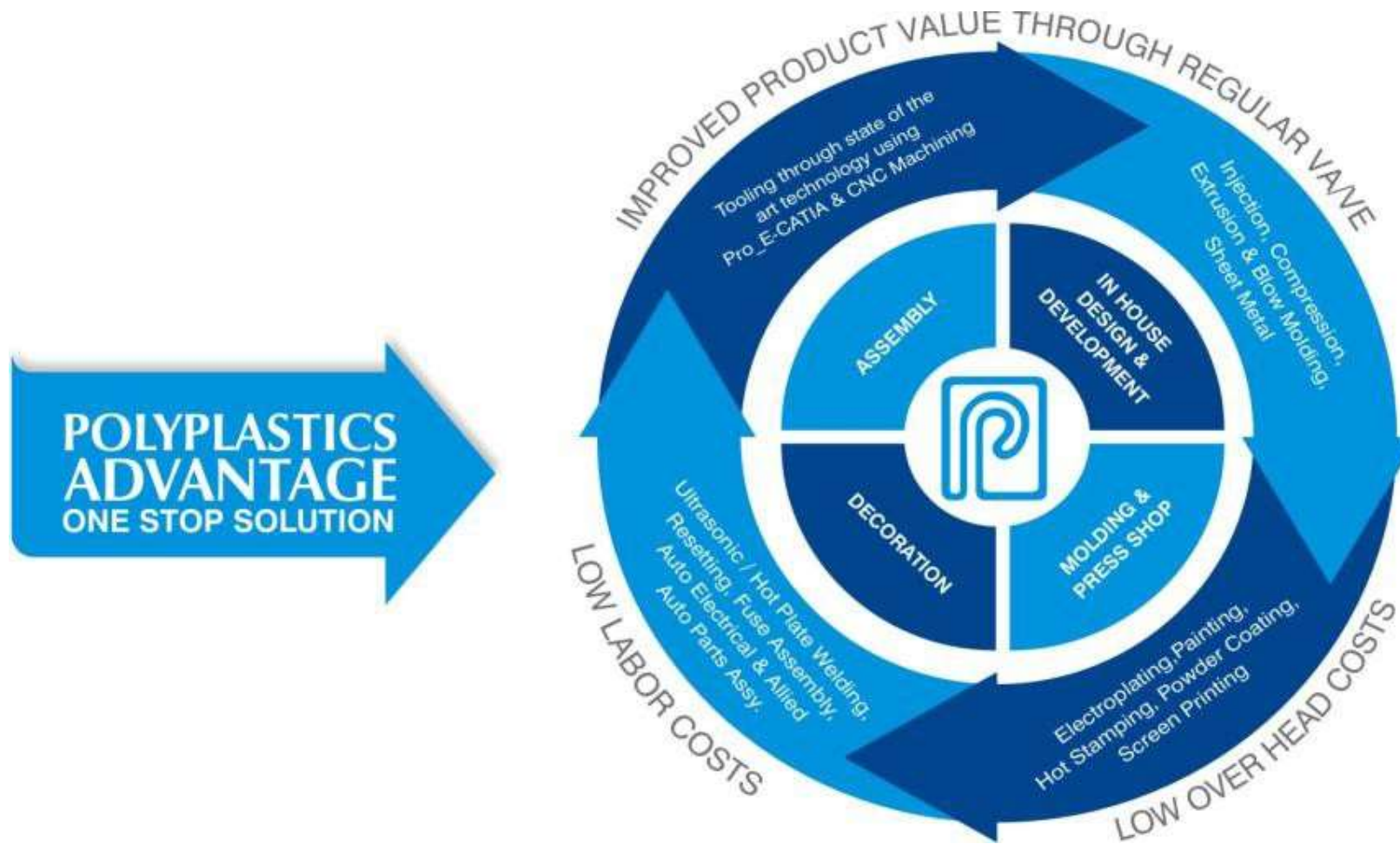

POLYPLASTICS GROUP REVENUE GROWTH YOY

IN MILLION INR

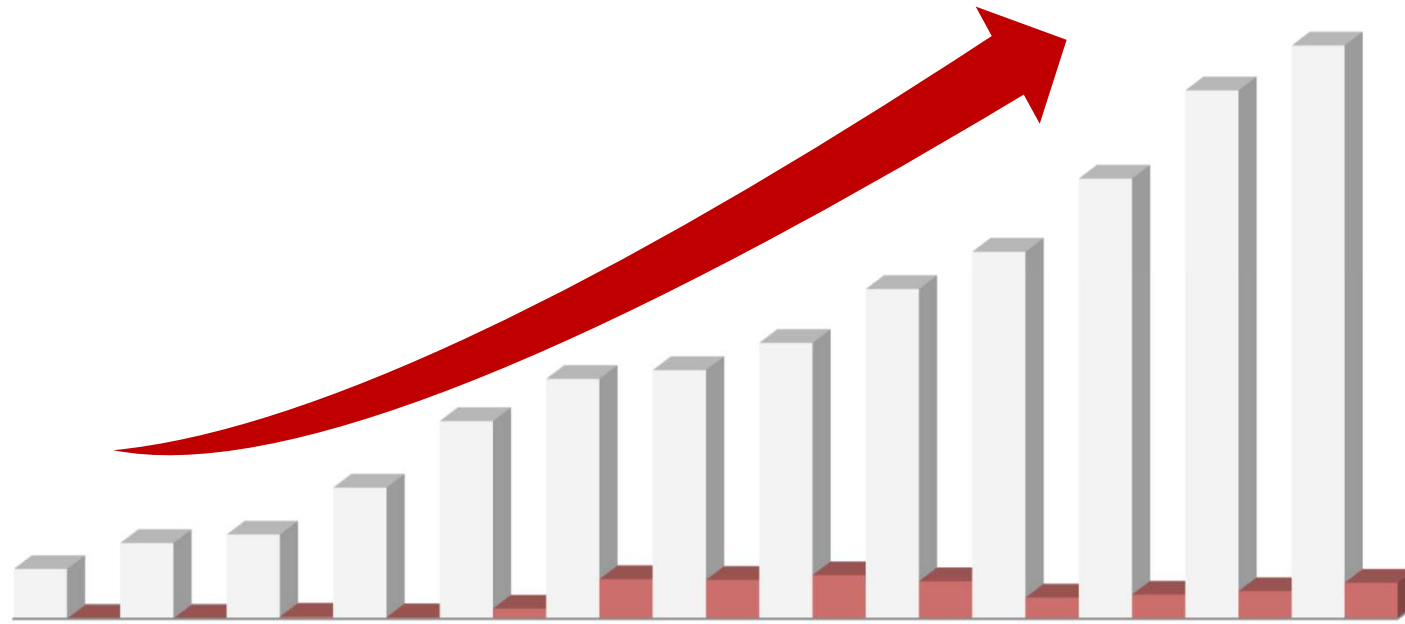

Year's	2006-07	2007-08	2008-09	2009-10	2010-11	2011-12	2012-13	2013-14	2014-15	2015-16	2016-17	2017-18	2018-19	2018-19
Domestic	443.50	675.68	751.95	1170.75	1762.85	1762.85	2216.00	2457.50	2936.50	3277.24	3927.80	4712.44	5111.77	5433.18
Export	0.00	1.83	18.05	12.75	90.40	354.00	347.00	388.50	335.50	189.00	215.40	246.70	321.41	

DOMESTIC CUSTOMERS SERVED

CAR MANUFACTURERS



TIER 1



COMMERCIAL & AGRICULTURE

TRUCKS



TRACTORS



TWO WHEELERS



OUR CAPABILITIES

PRODUCT ENGINEERING SOLUTIONS

- Automotive Products Design & Development
- Tools & Fixtures Design and Development
- Advance Project Management
- Product Data Management
- Engineering Change Management
- Costing & Sourcing

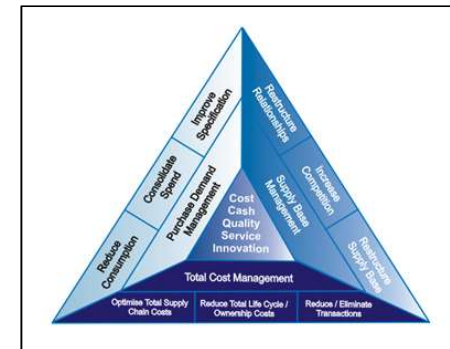
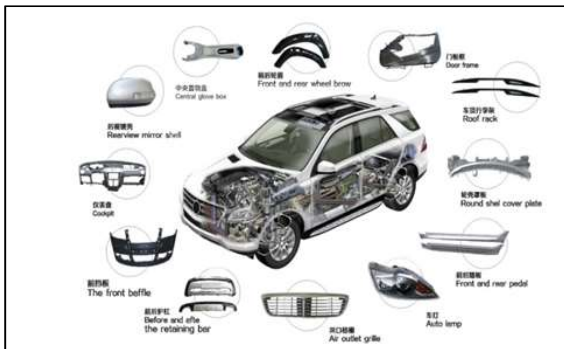
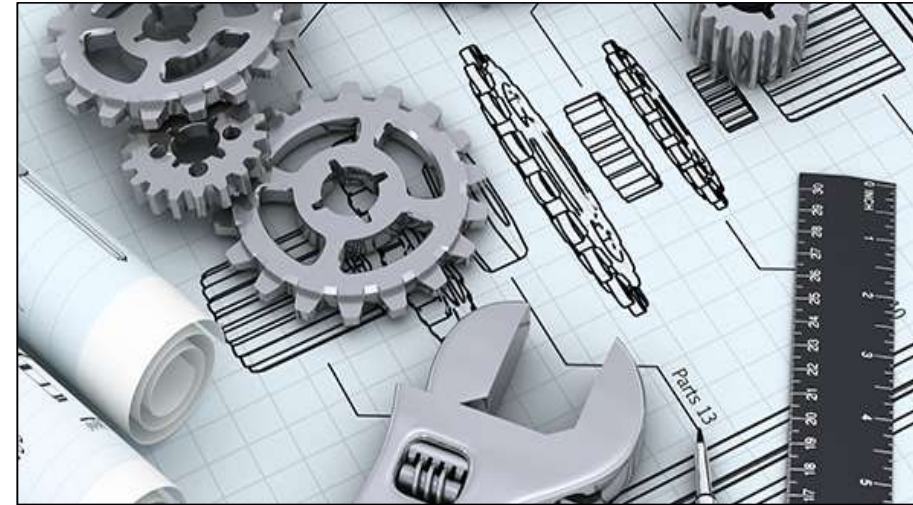

OUR CAPABILITIES

PRODUCT DEVELOPMENT SOLUTIONS

- Concept & Ideation
- Reverse Engineering
- Class-A Surfacing
- Product Design
- FEA / CAE Simulation
- Drafting & Detailing
- Product Prototyping & Testing

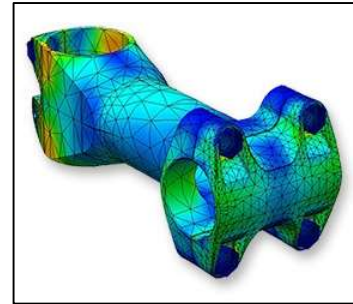
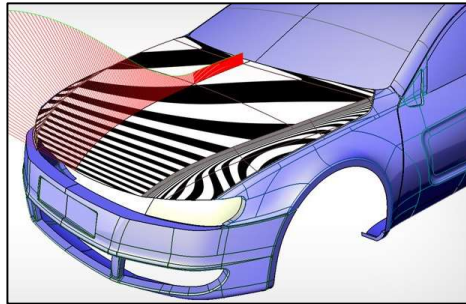
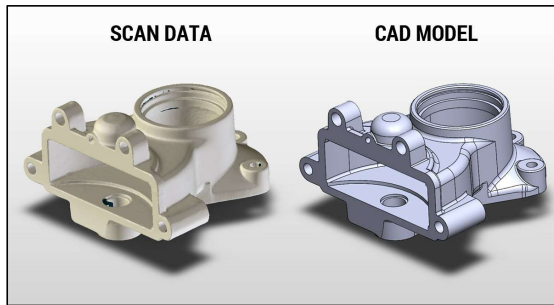
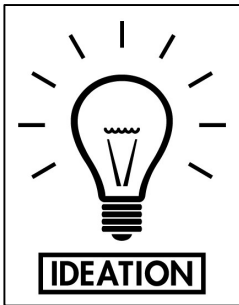
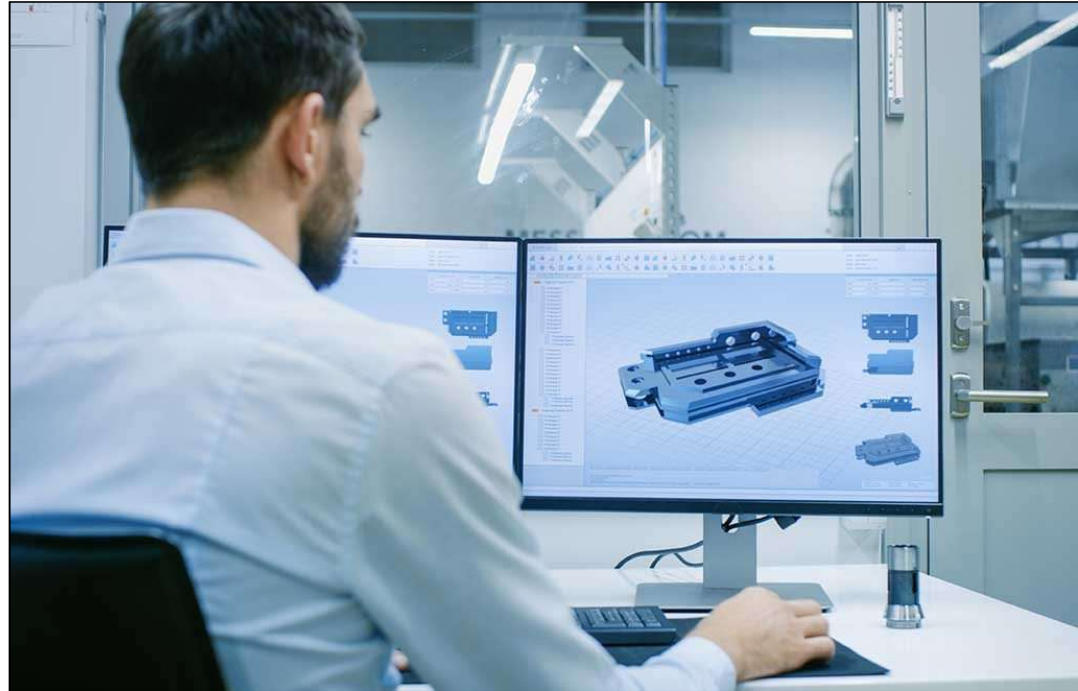

OUR CAPABILITIES

PRODUCT OPTIMIZATION SOLUTIONS

- Value Engineering
- Part Reduction
- Weight Reduction
- Product Localization
- Indigenization
- Performance Improvement

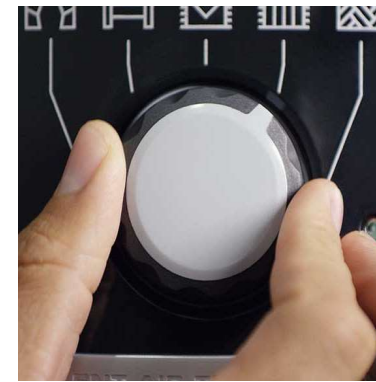
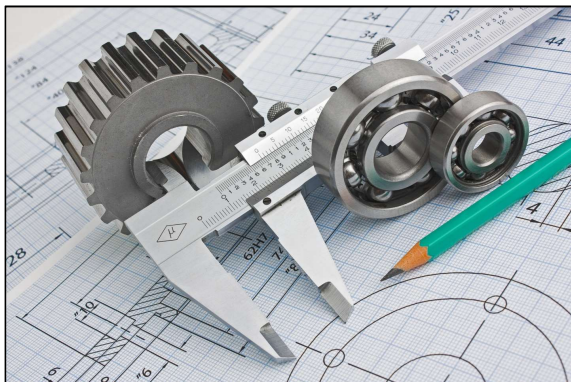
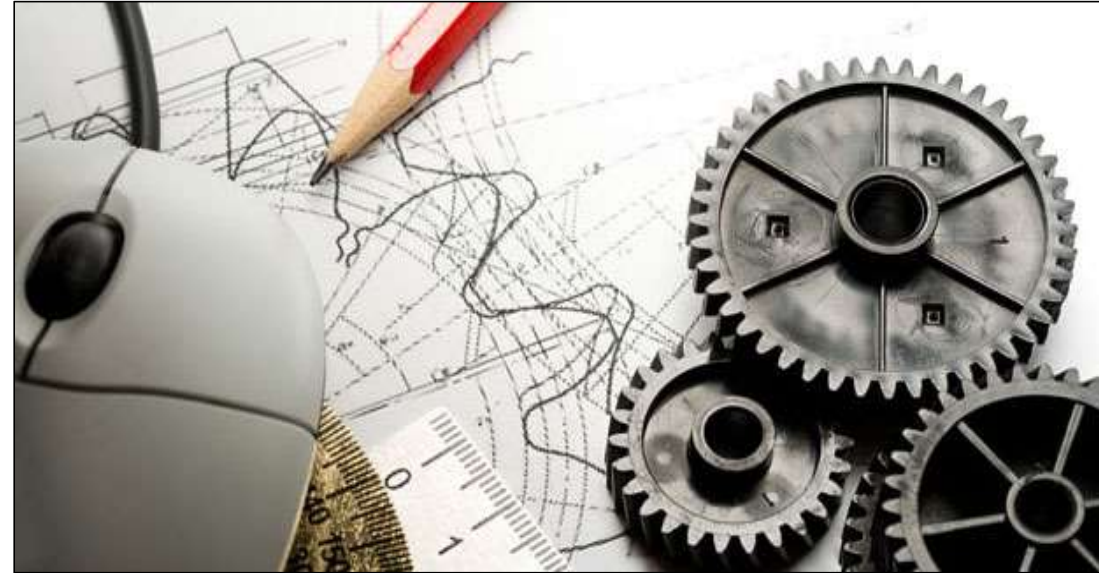

OUR CAPABILITIES

DIGITAL TECHNOLOGY SOLUTIONS

- Design Automation / API
- Product VR / AR
- Technical Publication
- Technology Sales
- Data Migration & Exchange

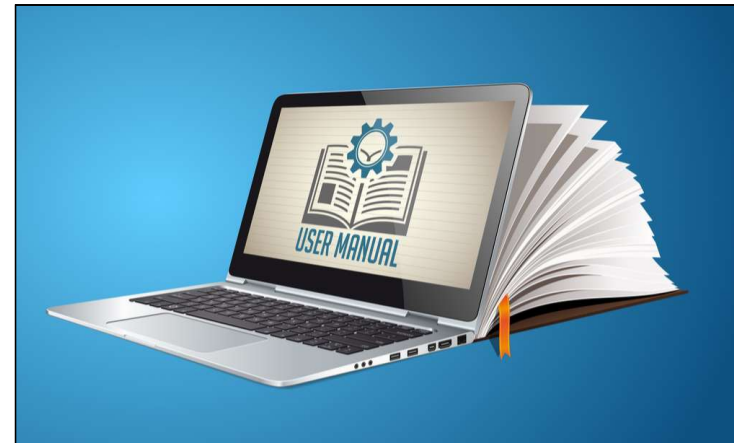
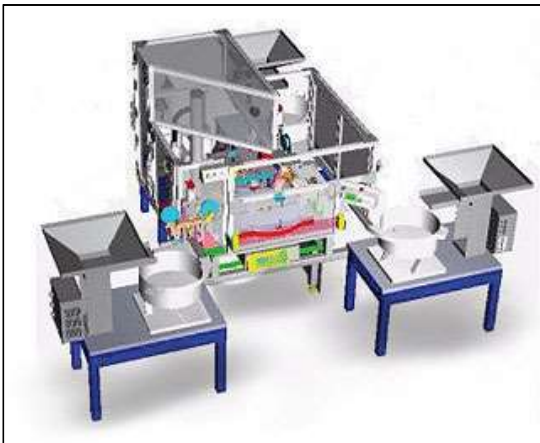

OUR CAPABILITIES

TECHNICAL WORKFORCE SOLUTIONS

- Automotive Product Experts
- Tool & Die Design Experts
- Project Management Experts
- Domain / Software Experts
- Data Analysts

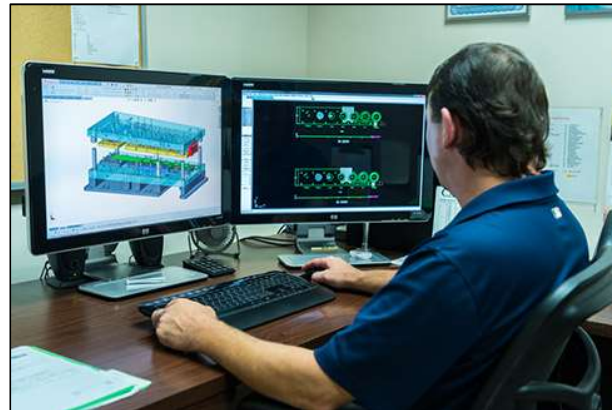

OUR FACILITIES

TECH-INNOVATION CENTRES

- Pune Tech Centre
- Gurgaon Tech Centre
- Yamunanagar Tech Centre
- Design Studio in Pune (Planned)

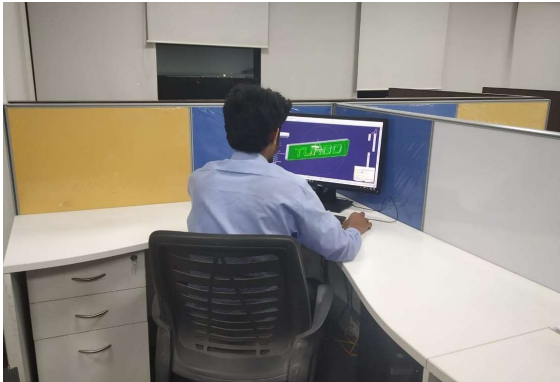

OUR FACILITIES

ENGINEERING SOFTWARE DEPLOYMENTS

- CAD- CATIA V5, UGNX, ARES
- CAE- MOLDFLOW, ANSYS Mech
- CAM- SOLIDCAM
- PLM- 3DEXPERIENCE (Planned in FY20-21)
- DATA EXCHANGE- GM NX Kit, NSTK
- 3D PRINTING-

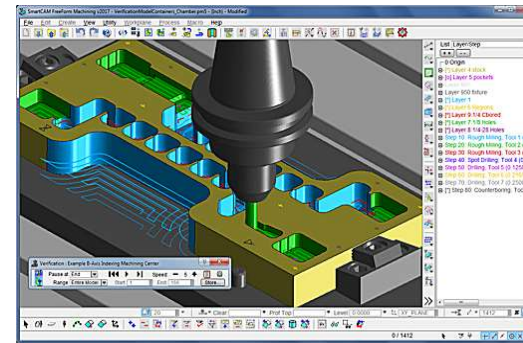
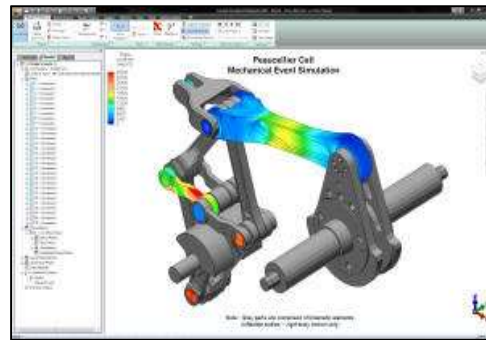

OUR FACILITIES

TECHNICAL WORKFORCE

- Automotive Product Experts- 18 Engineers
- Tool & Dies Experts- 20 Engineers
- R&D Experts- 6 Engineers
- Project Managers- 12 Engineers
- VAVE Experts- 8 Engineers

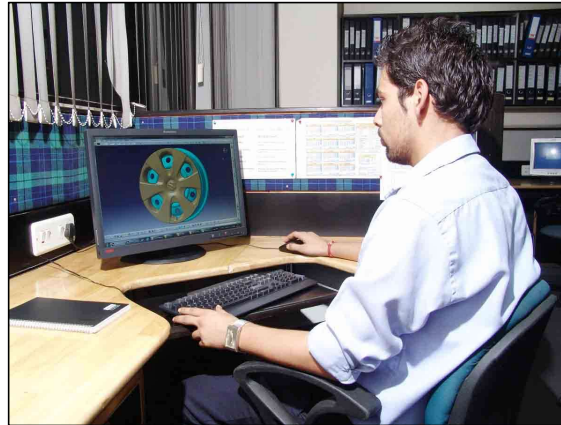

SUMMARIZING.....



CONTACT US @

OUR OFFICES

Registered Office:

Plot No. O-15,
Industrial Area
Yamunanagar, Haryana

Gurgaon Office:

201, Enkay Tower,
Udyog Vihar, Phase V
Gurgaon, Haryana

Pune Office:

701/702, Pride Icon
Mundhava Road, Kharadi Bypass,
Pune, Maharashtra

OUR WEBSITE

www.k2cadem.com

OUR EMAIL

info@k2cadem.com

OUR CONTACTS

Abhinav Jain @ +91 8295909553
Deepak Gupta @ +91 9996789574

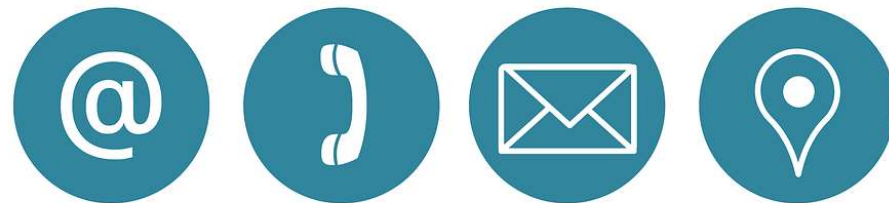

THANK YOU!



We at **K2 Cad-E-M Technologies** are
waiting to join hands with You!

